

SG

BLACKZON



BLACKZON
VYPER
TURBO

Startup Guide



540283-006-SG

THANK YOU

Thank you for selecting this Blackzon RC product! **HAVE FUN!** But please read this first !!

We know you will have great fun with your model, but to get the best from your purchase please read this information BEFORE you operate the model.

SAFETY PRECAUTIONS

This product is an authentic radio controlled vehicle (RC vehicle) and it is not a toy. Read and understand this instruction manual thoroughly before running the model. If you are not familiar with RC vehicles, we recommend that you ask someone familiar with RC vehicles for advice.

Never connect the rechargeable drive battery in the reverse polarity or disassemble the battery. If the drive battery is used in the wrong way, high current can be generated and it is very dangerous.

Never run RC models near people or animals, or on public streets or highways. This could cause serious accidents, personal injuries, and/or property damage.

Make sure the mains power socket when using a charger is readily accessible and never left plugged in when not in use.

If you are using Rechargeable AA's for the Transmitter please make sure you also purchase a suitable charger for this battery type.



Warning

Only use the supplied 2-cell battery.

Do not connect a 3S 11.1V LiPo using the balance port as this will cause a short circuit and result in product and battery damage, including high risk of fire.

GLOSSARY

Below are some common terms used in this manual.

Transmitter	Also called the Radio or Controller.
Receiver	The unit inside the car that receives the signal from the transmitter.
ESC (Electronic Speed Control)	Controls the motor's power and speed.
Servo	The small motor that turns the front wheels for steering.
LiPo Battery	A rechargeable "Lithium Polymer" battery used to power the model.
Trim	A fine-adjustment control that centers steering or throttle.
Dual Rate (D/R)	Adjusts how far the steering can turn left or right.
Binding / Pairing	Creating a communication link between the transmitter and receiver.
Neutral Position	The middle position of the throttle or steering where no movement occurs.

ABOUT US

BlackZon is dedicated to creating fun, durable, and affordable RC vehicles that anyone can enjoy — whether you're brand new to radio-controlled cars or already an experienced hobbyist. Our models are designed to be easy to use, easy to maintain, and ready for adventure straight out of the box.

We are part of the HPI Racing family, bringing together years of RC experience, product development, and support to deliver a great driving experience at every level.

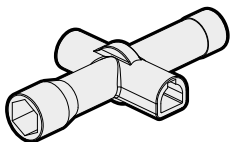
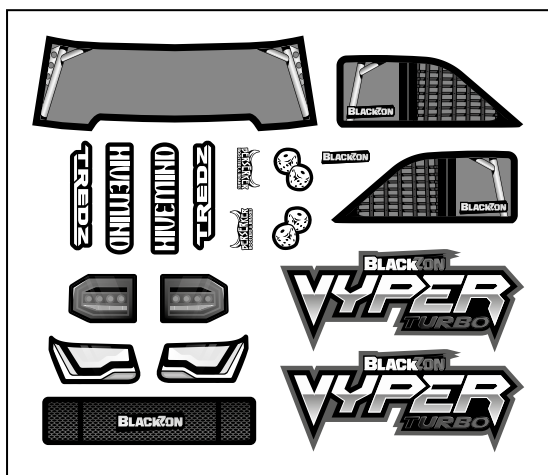
COMPONENTS**EQUIPMENT NEEDED**

x2

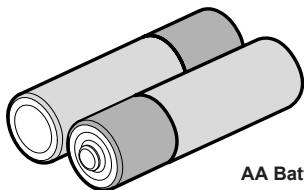

AA Batteries for Transmitter

TRANSMITTER INFORMATION

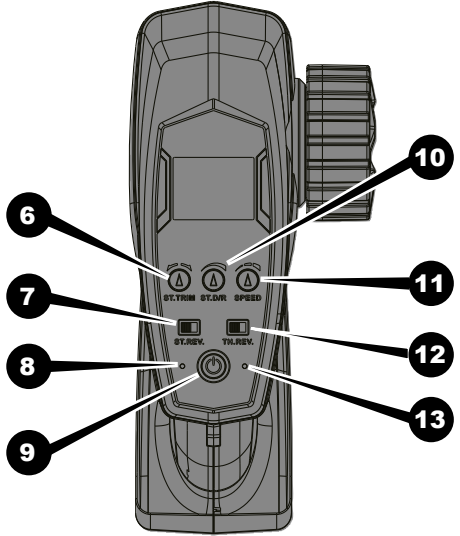
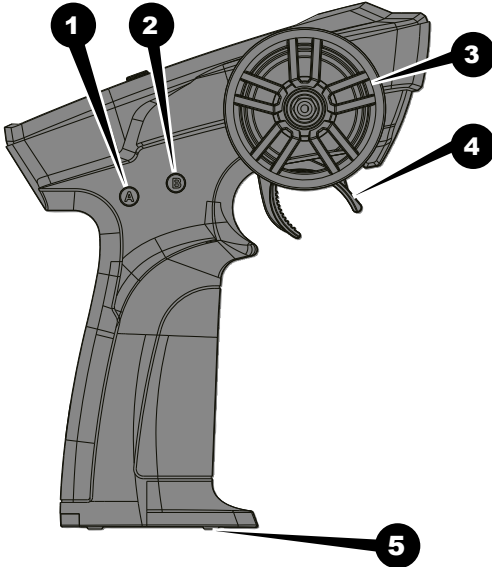

1. Function Button A
2. Function Button B
3. Steering Wheel
4. Throttle Trigger
5. Battery Compartment
6. Steering Trim
7. Steering Direction Reverse

8. Power indicator(Red)
9. ON/OFF Power Switch
10. Steering D/R
11. Speed Trim
12. Throttle Reverse
13. Power indicator(Green)

Power Indicators (Red/Green):

The lights indicate the current status of the transmitter batteries. When both power indicator lights are illuminated, the batteries have sufficient capacity to power the transmitter safely. If the green power indicator light begins to flash, the batteries are losing power and should be replaced soon. When both power indicators begin to flash, the batteries have only limited capacity to power the transmitter. In this case, the batteries should be replaced as soon as is safely possible.

ESC/RECEIVER INFORMATION

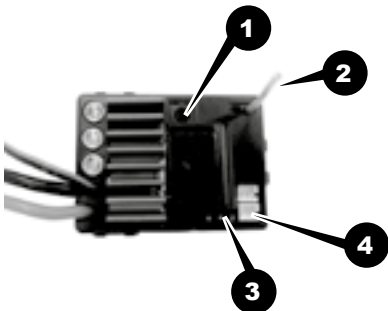

1. Power Switch: Press and hold for power switch for 2 -3 seconds to switch on or off.
2. Antenna
3. LED Slot for the headlight LED
4. Not in use

1 GETTING STARTED

Battery Information



Caution

Failure to follow the instructions below could result in damage to the product, personal injury, damage to property, and possibly fire.

ONLY USE THE INCLUDED CHARGER TO CHARGE THE BATTERY PACK.

Failure to use a proper charger may result in damage to the battery and possible fire.

LiPo batteries should always be charged in an open area away from flammable materials to reduce the chance of fire and property damage.

DO NOT LEAVE THE BATTERY PACK UNATTENDED WHILST CHARGING.

When charging the battery you should remain in constant observation to monitor the charging process and react to potential problems that could occur.

THE BATTERY SHOULD NEVER BE CHARGED INSIDE THE R/C VEHICLE OR INSIDE A FULL-SIZE VEHICLE.

It is recommended to charge and store the battery in a fireproof LiPo bag to reduce the risk of short circuit and property damage due to fire.

DO NOT USE DAMAGED OR LEAKING BATTERIES.

LiPo batteries should always be handled with care to prevent them from being punctured, dented, scraped or otherwise damaged.

If the battery begins to balloon or swell at any time, quickly and safely disconnect the battery and place it in a safe area away from flammable materials and observe it for at least 15 minutes.

Continuing to charge or discharge a battery that has begun to balloon or swell could result in a fire.

A battery that has ballooned or swollen should be discarded in a safe manner according to your local disposal regulations.

STORE THE BATTERY AT ROOM TEMPERATURE AND APPROXIMATELY 1/2 CHARGE.

Avoid storing the battery in environments that can reach high temperatures, like an automobile in direct sunlight. Storing the battery at minimum or maximum voltage will decrease the usable lifespan of the battery and may lead to cell damage, deterioration and swelling.

Do not allow the battery to come in contact with water or liquids. Submersing the battery could cause dangerous short-circuits and damage the battery.

Never place LiPo batteries in your pocket or any other area where they could come into contact with objects that could cause shorting, puncturing or other forms of damage.

1.1 Charge Car Battery

1. Remove retaining clips
2. Pull off the bodyshell to access the car battery



1 GETTING STARTED

1.1 Charge Car Battery

3. Release Velcro to remove battery.
4. Connect the Battery Pack: Attach the white plug of the battery pack to the USB charger. Refer to Figure 1.
5. Power Source: Plug a compatible phone charger into a wall outlet. See Figure 2.

The USB Charger requires a USB Adapter with an output of at least 2A (Not included)

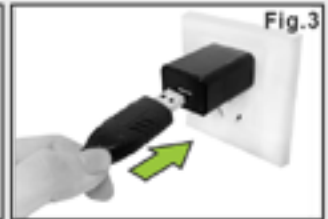





6. Connect USB Charger: Insert the USB charger into the phone charger. Refer to Figure 3.

Charging time is approximately 4-4.5 hours to fully charge.

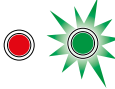
7. Re-fit car battery into car and connect red plugs

LED Status

	Solid Red:	Charger has power
	Solid Red and Flashing Green	Charging
	Solid Red and Green	Fully Charged
	Flashing Red	Damaged Battery (will not charge)
	Both LEDs off	Possible damage to charger

1.2 Install Transmitter Batteries



1. Open the battery holding tray to expose the empty battery slots.
2. Insert 2 AA batteries into the marked spaces.
3. Please note the correct direction of the batteries

Incorrect battery insertion could damage the transmitter.

2 SETUP

2.1 Decal Application

A decal sheet is included with your model. You can follow the suggested placement shown in the guide — or feel free to customize your model to create your own unique look!

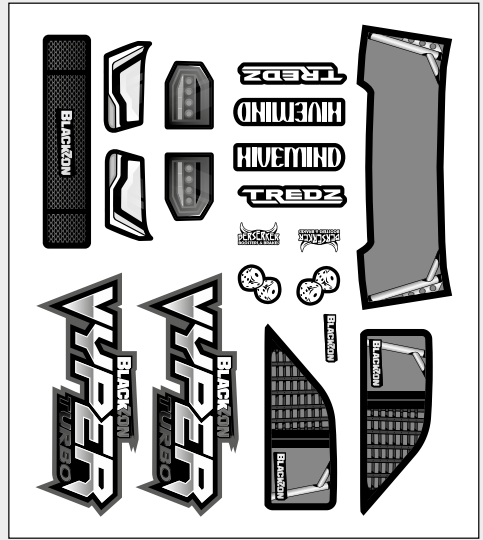

2.2 Binding/Pairing

The Transmitter will need to be bound (or “paired”) to the car receiver so that they can communicate with each other correctly. This should happen automatically when switching on - see Section 3 for more information.

2.3 Optional Headlights

This model comes with an optional Headlight LED. To fit:



1. Insert the lights into the slot on the back of the front bumper
2. Insert the plug into the LED slot on the ESC/Receiver

3 SWITCHING ON**Caution**

Turn on transmitter first and then turn on receiver.

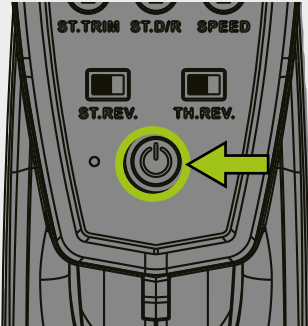
3.1 Switch on Transmitter

Press the power switch to turn on.

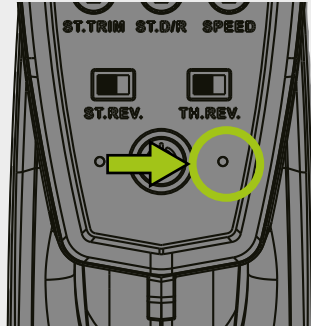
3.2 Check Battery level

The Red LED will show if the installed AA batteries have sufficient charge.

The Red LED will flash if the batteries need replacing.

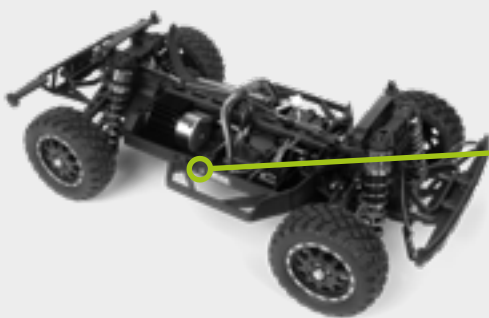
3.3 Switch on Receiver (Car)

Press and hold for 2-3 sec. to switch on

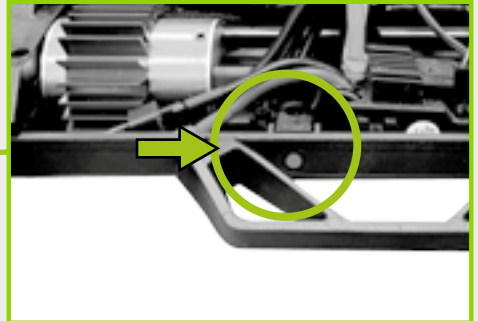
**Attention**

The car and transmitter should bind automatically so that the car operates using the transmitter after switching on.

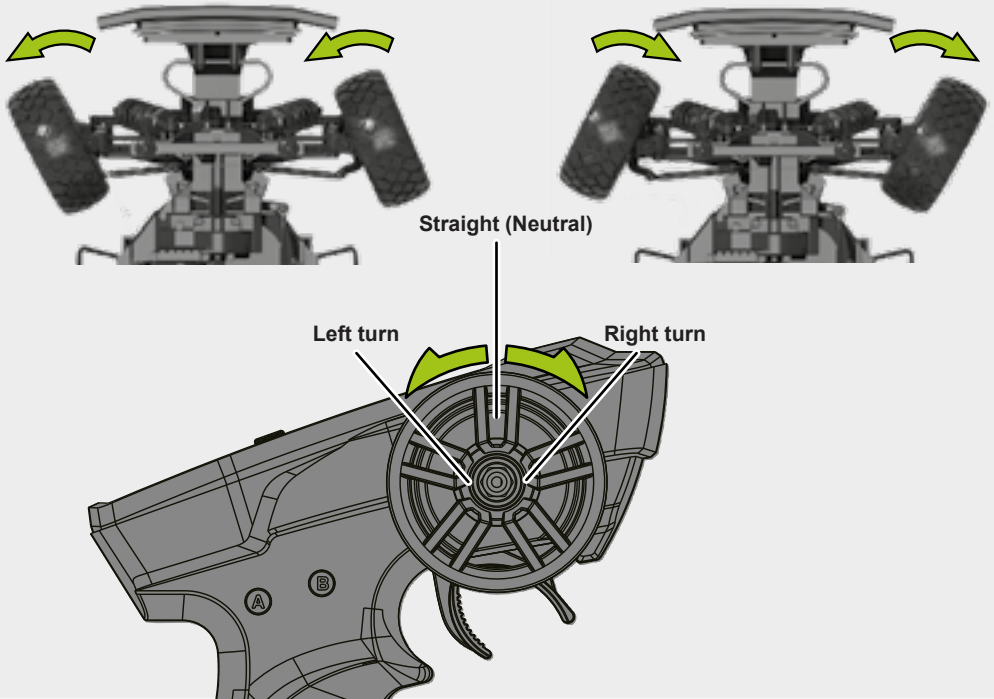
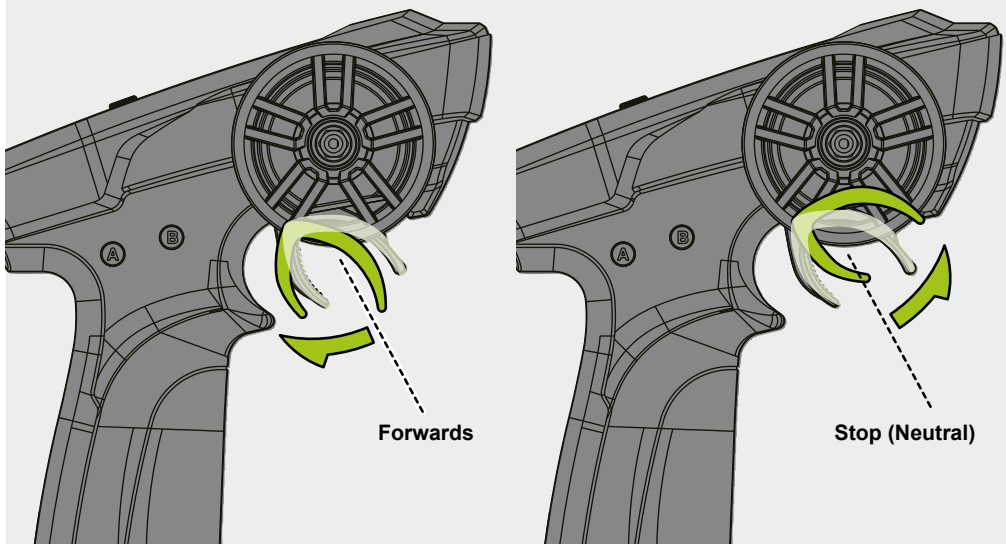
4 USING THE TRANSMITTER**4.1 Steering****4.2 Acceleration/Braking**

4 USING THE TRANSMITTER

4-3 Function Button A

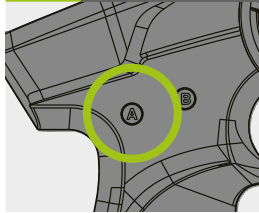

No function on this car.
The radio LED flashes but there is no function.

4-4 Function Button B

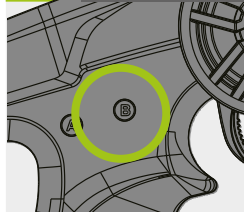

Car Lights On/Off
Press and hold the button B for 2-3 seconds to turn the car light on or off.

5 FAIL SAFE SYSTEM

This car has a built-in fail safe system that will stop the car if the radio glitches, either because of interference or if the car goes out of range.

The fail safe system has been setup at the factory, but you should become familiar with the function of the fail safe and check the operation before running.

To check the failsafe:

1. Set the car so that the wheels can turn, but it will not move, either by putting on a stand or turning upside down.
2. Turn on the transmitter, and then the car.
3. Move the throttle trigger to turn the car wheels (accelerate).
4. Whilst the car is running, turn off the transmitter.

If the failsafe is working, the car's wheels should stop turning.

6 CHECK RADIO RANGE

To check the radio range safely:

Ask a friend to hold the model securely while you walk to the farthest distance you plan to operate it. Use the transmitter controls to confirm that the model responds correctly.

If you notice any delay, loss of signal, or unusual behavior, do not operate the model until the issue is resolved.

Always switch on the transmitter first, then the model.

If the model is powered on before the transmitter, you may lose control.

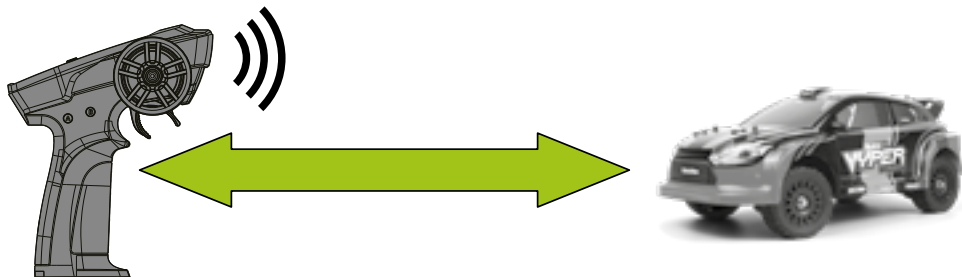

Cautions

2.4GHz radio frequency only functions by line of sight, if you drive behind a solid object or around a corner and lose sight of the vehicle you may lose control of the RC car.

7 BASIC TROUBLESHOOTING

Your car should be ready to go out the box, but some functions can be fine-tuned or changed to customise handling and performance.

7-1 Steering Trim Setup (ST TRIM)

The wheels should be central so that the car goes in a straight line if no steering is applied. The steering trim allows the tires to be set in a completely centered position.

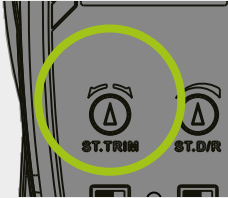

7-2 Steering Dual Rate (ST D/R)

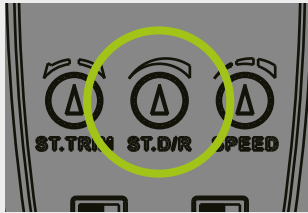

Steering Dual Rate:

The Steering Dual Rate (ST D/R) knob adjusts how far the front wheels turn when you steer.

1. Turn the knob clockwise to increase steering throw (tighter turning).
2. Turn the knob anticlockwise to reduce steering throw (smoother control).

For best handling, it's recommended to keep the steering throw within 75%.

This helps avoid excessive turning that can cause the front tyres to rub against the body shell and ensures smoother, more precise steering control.



Tip

Adjust the steering dual rate while driving to fine-tune handling — increase it for tight corners or decrease it for better stability at high speeds.

7-3 Speed Dial

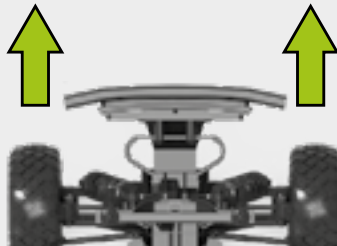
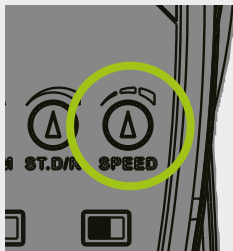

The speed dial is a throttle limiter. Turning the dial all the way down reduces the top speed to 40% of maximum speed. Turning the switch up increases the speed up to the full 100%.

7-4 Steering Reverse Switch



If the vehicle turns right when you steer left and turns left when you steer right, flip the "Steering Reverse" switch.

7-5 Throttle Reverse Switch



If the vehicle goes backwards when you pull the trigger, flip this switch.

8 AFTER USE

8.1 Switch off Receiver

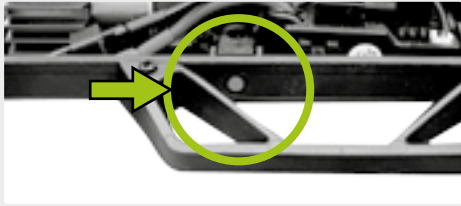

Press and hold for 2-3 sec. to switch of

8.2 Switch off Transmitter

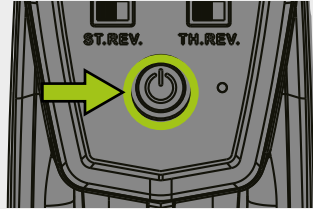

Press the power switch



Caution

If you switch off the transmitter first before the R/C car, you may lose control of the R/C car.

8.3 Disconnect Battery

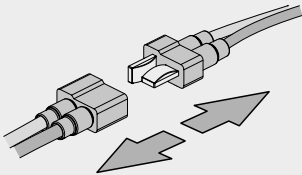

Disconnect the battery when you are not running the vehicle. The vehicle may run out of control or the battery can overheat and cause a fire.

8.4 Maintenance after driving

Regular maintenance is very important to keep your RC model in top condition.

After each run, clean the chassis and check all moving parts for any damage or wear.

If any parts are broken or worn out, repair or replace them before your next run.

Routine maintenance helps prevent damage and keeps your model performing reliably.

Completely remove any dirt or debris from the model, paying special attention to the suspension, drive shafts, and steering components.

Check that all screws and fasteners are tight and that no parts are missing or loose.

Use the schedule below as a general maintenance guide.

Interval	Maintenance Item
After every run	Clean chassis and suspension, remove dirt and debris.
Every 10 runs	Check wheels, tyres, and bearings. Inspect gears and drivetrain for wear.
Every 20 runs	Inspect and clean motor and pinion gears. Check differential and shock absorbers. Lubricate moving parts.
Occasionally	Check radio system, wiring, and connectors. Replace batteries if needed.



Tip

Perform maintenance more frequently if driving in dusty, wet, or sandy conditions.

TROUBLESHOOTING**A. The vehicle does not work at all:**

1. Check to ensure that radio controller and car are switched on.
2. Check if there are damaged parts/wires/connectors, repair or replace if necessary.
3. Car battery is flat. Charge the battery pack.

B. The vehicle runs slowly:

1. Car battery is flat. Charge the battery pack.
2. The throttle limiter is turned in too much (see page 7 of the instructions).
3. Check if the vehicle is properly geared and no dirty or stripped gears are found. Check the gear mesh for the motor pinion and spur gear.
4. Check if the moving parts have any problems and clean them immediately.

C. The throttle works but not the steering:

1. Check if the servo feels jammed, and try centering it gently if it does.
2. Check if the servo link is loose or if the servo is defective. Repair or replace if possible.

D. The vehicle steers, but there is no throttle control:

1. Check if there are damaged parts in the overall drive train.
2. Check the battery power both for radio controller and the car.

E. The vehicle drives noisily:

1. Check gear mesh between spur gear and motor pinion.
2. Check if there are stripped and/or dirty gears.
3. Check for any damage to any part throughout the drivetrain.

F. The vehicle does not steer the same amount in both directions.

1. Please adjust the steering trim until the steering center point is fixed.

G. Batteries cannot be charged:

1. Check if either the charger or the battery is damaged, or batteries are over-discharged.

FCC COMPLIANCE STATEMENT

This device transmits in the range 2.4 to 2.4835 GHz and has been tested to comply with the limits for a Part 15 Class B device of the FCC rules. These limits are designed to provide reasonable protection against harmful interference in a residential installation. This equipment generates, uses and can radiate radio frequency energy and, if not installed and used in accordance with the instructions, may cause harmful interference to radio communications. Any change or modification to the device not expressly approved by the manufacturer may void the user's authority to operate the equipment. Operation is subject to the following two conditions:

(1) This device may not cause harmful interference, and (2) This device must accept any interference received, including interference that may cause undesired operation.

Canada Compliance Statement:

This Class B digital apparatus complies with Canadian ICES-003. (Cet appareil numérique de la classe B est conforme à la norme NMB-003 du Canada.) This equipment complies with the FCC/IC radiation exposure limits set forth for FCC and Industry Canada portable transmitting devices operation in an uncontrolled environment. The equipment should only be used or installed at locations where there is normally at least a 20cm separation between the antenna and all persons. This transmitter must not be co-located or operated in conjunction with any other antenna or transmitter.

CE Compliance statement

The radio equipment type in this product transmits in the frequency range 2.4 to 2.4835 GHz with a maximum power of 18dBm and is in compliance with EU Directive 2014/53/EU. The full text of the Declaration of Conformity is available at www.hpiracing.com/ce

Cet appareil transmet dans la gamme de fréquence de 2,4 à 2.4835 GHz avec une puissance de 18dBm et est conforme à la Directive UE 2014/53 / UE.

Le texte intégral de la Déclaration de conformité est disponible sur www.hpiracing.com/ce

El tipo de equipo de radio en este producto transmite en el rango de frecuencia de 2.4 a 2.4835 GHz con una potencia máxima de 18dBm y cumple con la Directiva de la UE 2014/53/UE. El texto completo de la Declaración de conformidad está disponible en www.hpiracing.com/ce

BLACKZON

HPI RACING A/S

Jegindoevej 21

8800 Viborg, Denmark

WWW.BLACKZON.COM